

A photograph of a modern, two-story house at dusk. The house features large glass windows and a balcony. The interior lights are on, and the sky is a mix of purple and blue. In the foreground, there is a swimming pool with a wooden deck. The text "Prolonging your pool pleasure" is overlaid on the left side of the image.

Prolonging your pool pleasure

BWT UNDERWATER LIGHTS



Contents

TECHNICAL DATA	4
MASONRY/ LINER	6
CONCRETE	7
PANELS/ LINER	7
UNIVERSAL GUTS PACK WITH FLEXIBLE CLIPS	8
DECK BOXES	10
UNDERWATER LIGHT FACE TRIMS	11



UNDERWATER LIGHTS by BWT

TECHNICAL DATA:

Procopi BWT Group manufactures underwater lights in its factory located in Brittany in Northern France.

BWT's underwater lights incorporate the **latest technological innovations**, quality and reliability are guaranteed.

One single range compatible with pools waterproofed with a liner, traditional reinforced concrete pools and panel pools.

- Made of UV stable pool grade ABS,
- Adhesive, elastomer gaskets,
- Stainless steel screws, adapted to every type of pool,
- Adhesive, protective work-site covers,
- Available in several colours.

ABS gives the underwater lights a shiny, bright white finish (the shade of white is colour matched to Procopi BWT Group's liners and reinforced membranes), the ABS is **UV stable** so it remains unchanged over time and it **does not react with** pool chemicals, under normal operating conditions.

The underwater light is always the same, whether it is a "liner", "concrete" or "panel" version.



BWT underwater light

TECHNICAL DATA

UV STABLE ABS

The ABS gives BWT's underwater lights a bright, shiny white finish. Being UV stable, it remains unchanged over time. In addition, it does not react with pool chemicals under normal operating conditions.

EASILY ADAPTABLE

In the event of the renovation of a traditional concrete pool equipped with a BWT underwater light, a liner or 1.50 mm reinforced membrane can be fitted with no difficulty.

PANEL POOLS

BWT underwater lights are equipped with a fastening ring that allows them to be installed on prefabricated pool structures. The flange is counter-bored to house the heads of the fastening screws when the underwater light is mounted on a thin wall.

SOLIDLY FASTENED GUTS PACK

The guts pack is held in the underwater light niche by 2 screws. It cannot be accidentally pulled out, for example, by people leaning against the underwater light.

45° OUTLET

The underwater light features a 45° cable outlet to the rear of the niche that allows the cable to be run vertically or horizontally. Connection of the protective sheath that houses the power cable is simple, there are no bends that could hinder running of the cable. A cable gland ensures waterproofing at the point where the electrical cable passes into the body of the niche.

CORRUGATED SHEATH

Thanks to its movable union, the corrugated sheath can be cut to the exact length that separates the niche from the deck box. This prevents the formation of bends that could make it difficult to run cables through the sheaths. The corrugated sheath is ICT standard compliant so there is no risk of compression or crushing by concrete or backfill. A union, screwed onto the end of the sheath, creates a leaktight seal between the sheath and the deck box.

ELECTRICAL CABLE

The underwater light is equipped with a 2.3 m electrical cable, HO7RNF - RO2V, 1.5 mm², that is specially designed and manufactured according to the standards in effect for use in a pool. It is not deteriorated by chlorinated products and does not degrade over time.



IP-X8

The underwater light complies with the strictest electrical insulation standards imposed by NF C15-100 for devices installed in swimming pools. It is also approved by the SASO (Saudi Arabian Standard Organisation), for sale in Saudi Arabia.

WORK-SITE PROTECTION

A self-adhesive work-site cover is delivered with the underwater light to protect the niche and screw housings from damage or obstruction with mortar or cement during building work.

LAMP

The General Electric PAR-56 13.5 Watt (white LEDs) and 16 Watt (colour LEDs)/ 12 Volts lamps equipping the underwater light are widely recognised as the best on the global market in terms of their energetic performance and service life.

LAMP WATERPROOFING

Lamp waterproofing, in the guts pack, is ensured by a lip seal that absorbs any irregularities on the glass enclosure of the lamp. There is no risk of leaks or damage to the lamp.

SINGLE SCREW TYPE

All screws equipping BWT underwater lights are identical and are made of 18/10 stainless steel. It is easy to keep a stock on hand for after sales needs.

SELF-ADHESIVE GASKETS

Liner type BWT pool fittings are delivered with 2 self-adhesive elastomer gaskets that are very easy to install and that do not react with the chemicals used to treat swimming pools.

LED lamps

MASONRY/ LINER

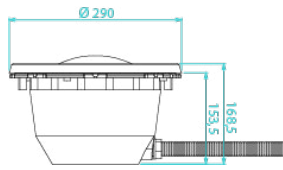

Light blue 44006081	Dark blue 44006082	Beige 44006085
Grey 44006088	Anthracite grey 44006087	Black 44006089

BWT PL-07V-M

Code : 44006000 – White LEDs, 13,5W – 12V, screw mounting

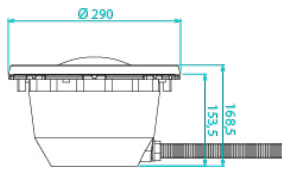

Light blue 44005081	Dark blue 44005082	Beige 44005085
Grey 44005088	Anthracite grey 44005087	Black 44005089

BWT PL-06V-M

Code : 44005000 – RGB colour LEDs, 16W – 12V, screw mounting

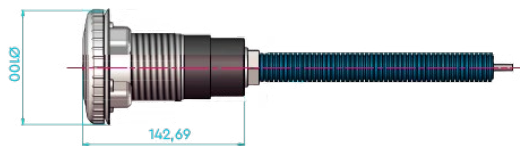

BWT PL-10-M

Code : 44075000 – White LEDs, 3W – 12V, mounted in the body of a return fitting

Halogen lamp

MASONRY/ LINER

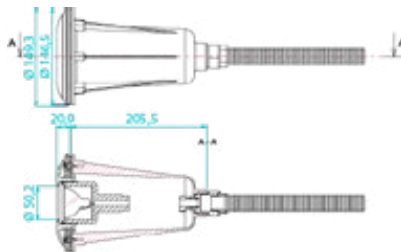

BWT PH-04

Code : 44050000 – 50W – 12V, with niche and cable duct

LED lamps

CONCRETE

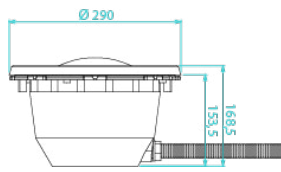

Light blue 44006081	Dark blue 44006082	Beige 44006085
Grey 44006088	Anthracite grey 44006087	Black 44006089

BWT PL-07V-M

Code : 44006000 – White LEDs, 13,5W – 12V, screw mounting

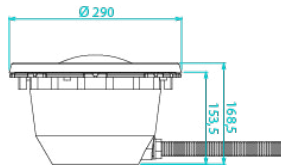

Light blue 44005081	Dark blue 44005082	Beige 44005085
Grey 44005088	Anthracite grey 44005087	Black 44005089

BWT PL-06V-M

Code : 44005000 – RGB colour LED, 16W – 12V, screw mounting

Halogen lamps

CONCRETE

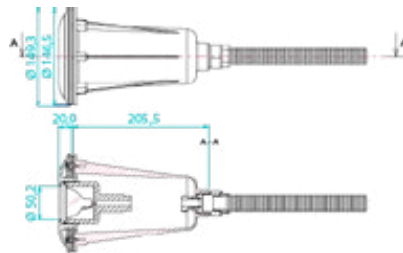

BWT PH-04

Code : 44050000 – 50W – 12V, with niche and cable duct

LED lamps

PANEL/ LINER

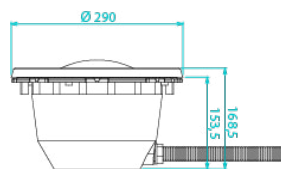

Light blue 44006081	Dark blue 44006082	Beige 44006085
Grey 44006088	Anthracite grey 44006087	Black 44006089

BWT PL07V-M

Code : 44006000 – White LEDs, 13.5W – 12V, screw mounting

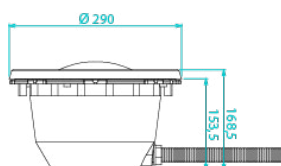

Light blue 44005081	Dark blue 44005082	Beige 44005085
Grey 44005088	Anthracite grey 44005087	Black 44005089

BWT PL06V-M

Code : 44005000 – RGB colour LEDs, 16W – 12V, screw mounting



Universal guts pack with flexible clips

GIVE YOUR POOL A NEW LEASE OF LIFE

The BWT universal guts packs can be mounted in any of the niches commonly found on the market.

The LED guts pack comprises the underwater light face ring, an Ecoproof bulb and stainless steel clips.

The 300W 12 volt guts pack is equipped with a 2.3 m cable and stainless steel clips.



1 WATERPROOFING

A cable gland to ensure leaktightness, accepts cables with a cross section from 9 mm (HOR7RNF, 2×1.5mm²) to 13.5 mm (HOR7RNF, 2×4 mm²).

2 CONNECTION

To the rear, there is a connection chamber to allow connection of the power cable with a threaded lid fitted with an o-ring.





3 MOUNTING

Special screw shims hold the lamp in the underwater light ring

4 TABS

Flexible metallic tabs covered with PVC allow the light to adapt to the various niches found on the market.

*Ideal for renovation projects
and replacements*

	 White	 Beige	 Grey	 Anthracite grey
300 W incandescent	44091000	44091500	44091800	44091700
White LEDs	44081000	44081500	44081800	44081700
RGB LEDs	44095000	44095500	44095800	44095700



DECK BOXES



Code	Reference	Description
45000000	BC-84	Universal deck box, 2 outlets and 1 outlet - White
45000500	BC-84-S	Universal deck box, 2 outlets and 1 outlet - Beige
45000800	BC-84-G	Universal deck box, 2 outlets and 1 outlet - Grey
45000700	BC-84-GA	Universal deck box, 2 outlets and 1 outlet - Anthracite grey



Face trim for stationary underwater light

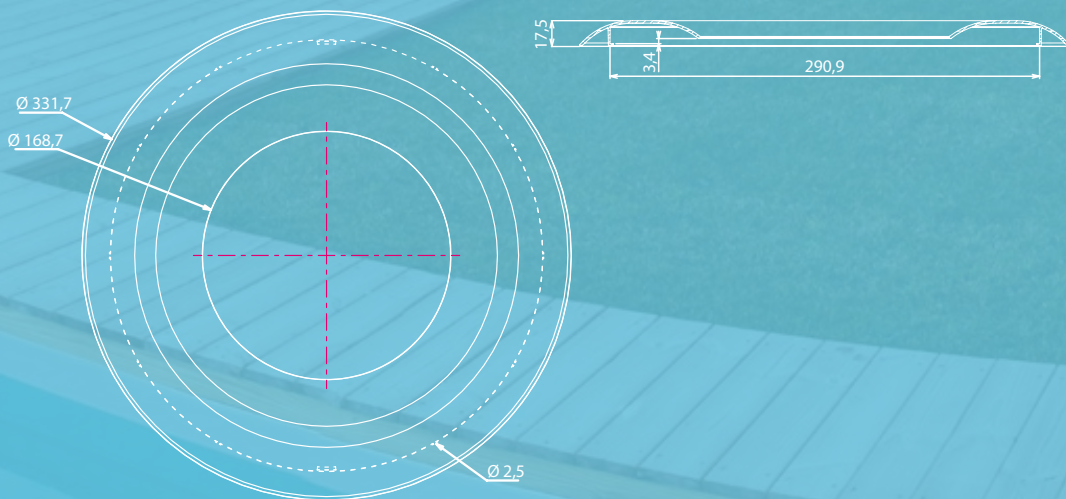

BWT offers a selection of its underwater lights in 4 colours: White, Beige, Grey and Anthracite. grey

UNDERWATER LIGHT FACE TRIMS



Light blue	Blue grey	Dark blue	Mint	Beige	Grey	Taupe	Clay	Anthracite grey	Black
------------	-----------	-----------	------	-------	------	-------	------	-----------------	-------

Face trims for stationary underwater lights

44900081	44900092	44900082	44900093	44900085	44900088	44900091	44900095	44900087	44900089
----------	----------	----------	----------	----------	----------	----------	----------	----------	----------



Dealer's stamp:

A large, empty rectangular box with rounded corners and a thin black border, intended for a dealer's stamp.